



KERN & Sohn GmbH

Ziegelei 1

D-72336 Balingen

E-Mail: info@kern-sohn.com

Tel: +49-[0]7433- 9933-0

Fax: +49-[0]7433-9933-149

Internet: www.kern-sohn.com

Service manual Price calculating balance

KERN RIB

Version 1.0

06/2016

GB



RIB-HM



RIB-M



KERN RIB

Version 1.004/2016

Service manual

Content

1	Basic Information	- 3 -
2	Introduction	- 3 -
3	Keyboard overview	- 4 -
4	Adjustment	- 6 -
4.1	Procedure when adjusting:	- 7 -
5	Service modes	- 9 -
5.1	Backlite settings	- 9 -
5.2	Interface settings / beeper	- 10 -
5.3	G Value settings.....	- 11 -
5.4	Key test.....	- 12 -
5.5	Battery status.....	- 13 -
6	Internal Settings	- 13 -
6.1	Scale Setting Max load.....	- 14 -
6.2	Decimal point setting	- 14 -
6.3	G Value setting.....	- 14 -
6.4	PLU setting.....	- 15 -
6.5	Error messages.....	- 15 -
6.6	Low battery warnings.....	- 15 -
6.7	LOADCELL connection (for indicator)	- 15 -
7	Circuit diagram	- 16 -
8	Explosion drawing	- 20 -

1 Basic Information

The device must be repaired only by trained specialist staff or personnel with professional formation (such as a repair-specialist accredited by law concerning verification). The service manual is obligatory for repair work. After repair, original conditions of the device have to be restored. Only original spare parts should be used.

Instructions about conformity-evaluated scales:

Repair must be carried only at 100% compliance with the type approval. A violation of this specification will result in a loss of the type approval! After successful repair the balance will have to be reverified before it can be used again in a statutorily regulated field.

Detailed instructions about conformity-evaluated scales:

Repair must be carried only at 100% compliance with the type approval. A violation of this specification will result in a loss of the type approval!

After successful repair the balance will have to be reverified before it can be used again in a statutorily regulated field.







2 Introduction

This service manual covers the RIB series and is edited for the authorized servicing personnel. Note all rights are reserved. Copying any part of this manual is prohibited without our permission.

In this lineup it is an eco product, Therefore, it is not intended to represent the repair manual in detail, since the construction of the balance is very simple.

3 Keyboard overview

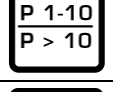

Selection	Function
	<ul style="list-style-type: none"> • PLU keys
	<ul style="list-style-type: none"> • Numeric keys
	<ul style="list-style-type: none"> • Delete basic price <ul style="list-style-type: none"> - In menu:Exit function / back to weighing mode.
	<ul style="list-style-type: none"> • Store basic price
	<ul style="list-style-type: none"> • Change between the memory locations 1-10 and 11-20
	<ul style="list-style-type: none"> • Calculate sales price

M+	<ul style="list-style-type: none"> • Addition in sum memory <ul style="list-style-type: none"> - In menu: Confirm entry 	
MR	<ul style="list-style-type: none"> • Call up total memory 	
MC	<ul style="list-style-type: none"> • Delete summation memory • Delete current counting 	
BAR	<ul style="list-style-type: none"> • Calculating the change 	
→0←	<ul style="list-style-type: none"> • Zeroing <ul style="list-style-type: none"> - Change back in menu - For numeric entry: Move decimal point to the left 	
TARE	<ul style="list-style-type: none"> • Taring 	<p>In menu:</p> <ul style="list-style-type: none"> • Call menu together with  • Change forward in menu <p>For numeric entry:</p> <ul style="list-style-type: none"> • Move decimal point to the right
ON	<ul style="list-style-type: none"> • Switch on balance 	
OFF	<ul style="list-style-type: none"> • Switch off the balance 	

4 Adjustment

As the acceleration value due to gravity is not the same at every location on earth, each balance must be coordinated - in compliance with the underlying physical weighing principle - to the existing acceleration due to gravity at its place of location (only if the balance has not already been adjusted to the location in the factory). This adjustment process must be carried out for the first commissioning, after each change of location as well as in case of fluctuating environment temperature. To receive accurate measuring values it is also recommended to adjust the balance periodically in weighing operation.

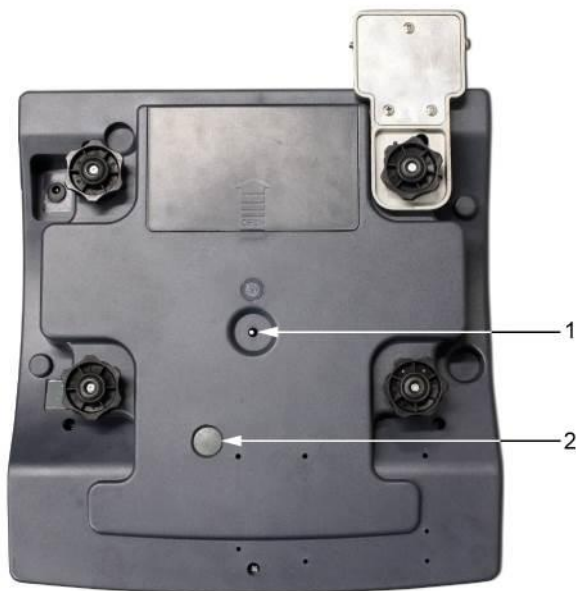

KERN	RIB 6K-3HM RIB 6K-3	RIB 10K-2HM RIB 10K-2	RIB 30K-2HM RIB 30K-2
Weighing range (max)	3 kg / 6 kg	6 kg / 15 kg	15 kg / 30 kg
Readability (d)	1 g / 2 g	2 g / 5 g	5 g / 10 g
Minimum load (Min)	20 g; 40 g	40 g; 100 g	100 g; 200 g
Verification value (e)	1 g / 2g	2 g / 5 g	5 g / 10 g
Verification class	III	III	III
Reproducibility	1 g / 2 g	2 g / 5 g	5 g / 10 g
Linearity	$\pm 1 \text{ g} / \pm 2 \text{ g}$	$\pm 2 \text{ g} / \pm 5 \text{ g}$	$\pm 5 \text{ g} / \pm 10 \text{ g}$
Recommended adjusting weight (not supplied)	5 kg; 1 kg (F2)	10 kg; 5 kg (M1)	20 kg; 10 kg (M1)



2. Adjustment switch

4.1 Procedure when adjusting:

Observe stable environmental conditions. A warming up time (10 min) is required for stabilization. Ensure that there are no objects on the weighing pan.
Arrange adjustment weight, see chart on p. 6“

	<p>In weighing mode press  and keep pressed; additionally press .</p>
--	---

	<p>If „CAL OFF“ appears in the window of the basic price or if the balance does not react, the verification switch on the lower side of the balance must be set to position „ON“.</p>
--	---

	<p>The value of the adjustment weight appears. The first digit is flashing. Either</p> <ul style="list-style-type: none"> - Take over the displayed adjustment weight, <p>or</p> <ul style="list-style-type: none"> - use the numeric keys to enter a new adjustment weight <p>Put adjustment weight in the centre of the weighing plate and confirm by .</p>
--	--

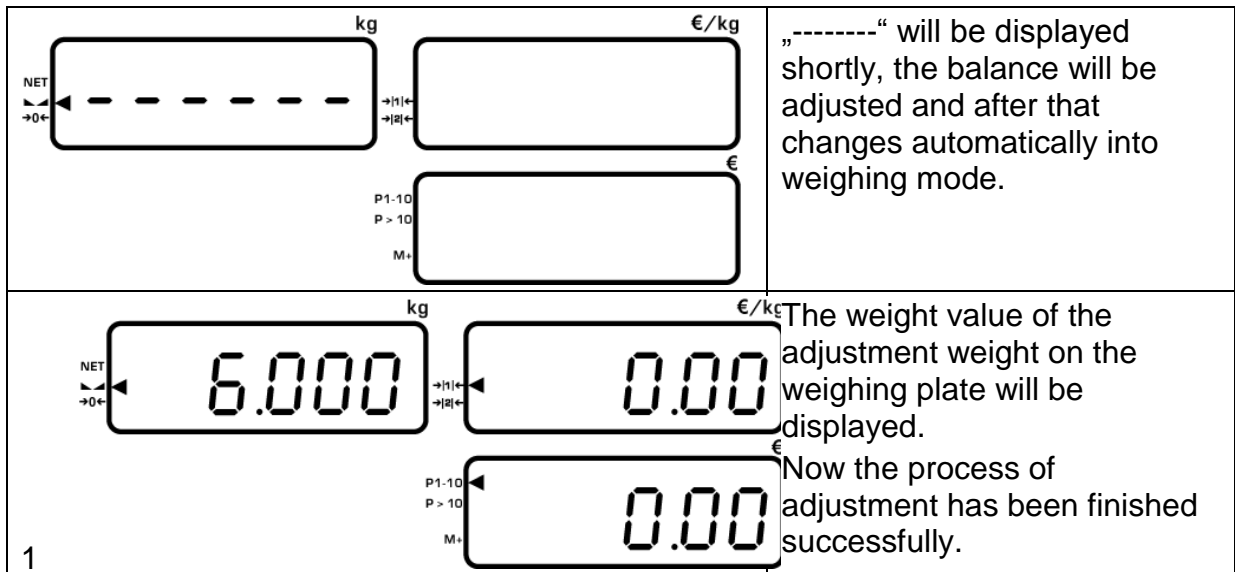







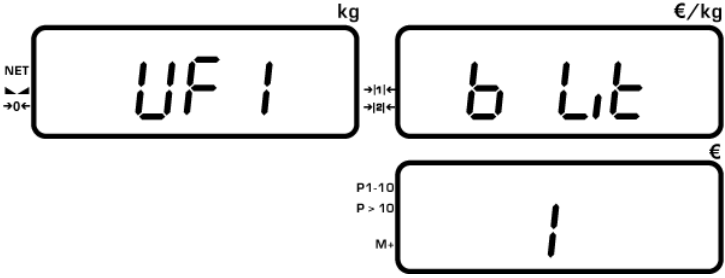

i In case of an adjustment error or incorrect adjusting weight the display will show an error message; repeat adjustment process.

5 Service modes

This overview of the service parameters is merely for checking the parameters set by the appropriate Bureau of Standards. No changes may be made.



5.1 Backlite settings

<p>Call up menu</p> 	<p>In weighing mode press  and keep pressed; additionally press . The first menu item UF1 (background illumination) will be displayed</p>
<p>Select menu block</p> <ul style="list-style-type: none">• Use  to change menu item backward• Use  to change menu item forward	
<p>Set parameter</p> <ul style="list-style-type: none">• Using numeric key  to 	
<p>Confirm setting</p> <p>⇒ Press </p>	
<p>Back to weighing mode / exit function without saving</p> <p>⇒ Press </p>	

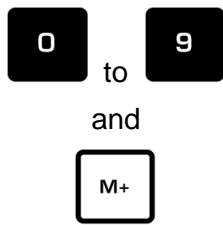
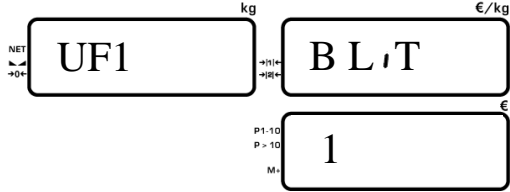
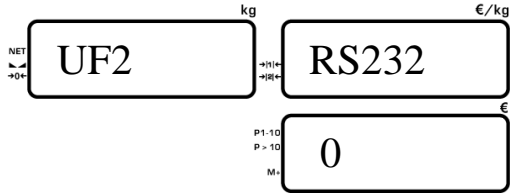
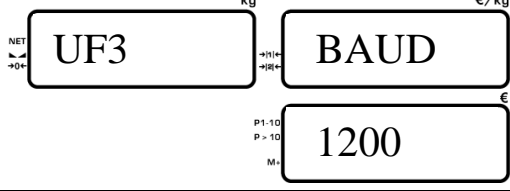
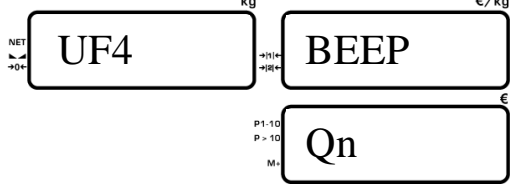
5.2 Interface settings / beeper

Function	Settings	Description
		
	<p>1</p> <p>0</p>	<p>Background illumination</p> <p>Background illumination automatically off</p> <p>Background lighting off</p>
	<p>0-3</p>	<p>not documented</p>
	<p>1200, 2400, 4800, 9600</p>	<p>not documented</p>
	<p>0</p> <p>1</p>	<p>Signal tone when pressing button</p> <p>Signal tone off</p> <p>Signal tone on</p>

5.3 G Value settings

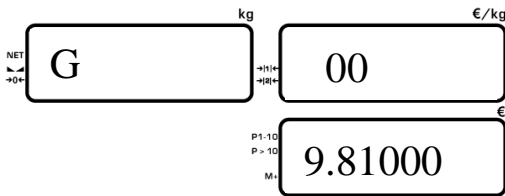
Buttons	Display	Description
in weighing mode		
Press  and keep pressed and press  additionally	 <p>The display shows three lines of information: <ul style="list-style-type: none"> Top line: 'G' on the left, 'kg' on the right. Middle line: '00' on the right, '€/kg' on the right. Bottom line: '9.81000' on the right, '€' on the right. There are also small labels 'NET', 'P1-10', 'P > 10', and 'M.' near the display elements.</p>	Display gravity settings.

5.4 Key test

Buttons	Display	Description
in weighing mode		
<p>Press TARE and keep pressed</p> <p>and press 5 additionally</p>		<p>① Keyboard test</p> <p>② Adjustment weight internal value (example)</p> <p>③ Software version (example)</p>

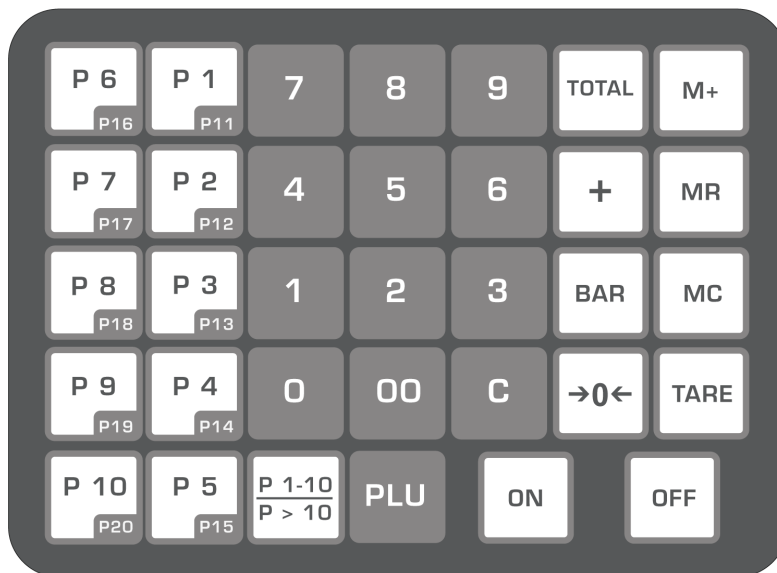

06	05	04	03	02	01	00
16	15	14	13	12	11	10
46	45	44	43	42	41	40
26	25	24	23	22	21	20
36	35	34	33	ON		OFF

Tabelle 5-1 shows the value if you press a key

5.5 Battery status

Buttons	Display	Description
in weighing mode		
Press TARE and keep pressed and press 6 additionally		Battery voltage internal value AD converter value① (example)

6 Internal Settings

Function	Settings	Description
Press TARE and keep pressed and press 1 additionally	0 to 9 and M+	
		Calibration switch SW 1 in off position. To enter calibration settings switch it On.
		Calibration switch SW 1 in ON position. Parameter for D1 to D5 in the following table

Press **0** **9** **TARE** **→0←** keys to enter specifications , Press the **M+** key to start the weight calibration, (Press the **C** key to exit back to weighing mode. Exit before calibration is completed; all data will not be saved)

6.1 Scale Setting Max load

D1 D2	Capacity and Division	Price Unit	Range	Weighing Unit	Resolution	Model
1 4	6.000kg* 1g/2g Divide at 3.0000kg	100g	Dual Range	No display	3000	RIB 6K-3M RIB 6K-3HM
1 5	15.000kg*2g/5g Divide at 6.000kg	kg	Dual Range	No display	3000	RIB 10K-3M RIB 10K-3HM
1 6	30.000kg*5g/10g Divide at 15.000kg	kg	Dual Range	No display	3000	RIB 30K-2M RIB 30K-2HM

Table 6-1

6.2 Decimal point setting

D3	Unit Price Decimal Point (Cent)
0	Unit Price/Total Price : Fixed no cent
1	Unit Price/Total Price : Fixed 0.0
<u>2</u>	Unit Price/Total Price : Fixed 0.00
3	Unit Price/Total Price : Fixed 0.000
4	Unit Price : Manual cent 0.00 Total Price : Fixed no cent
5	Unit Price : Manual cent 0.00 Total Price : Fixed cent 0.0
6	Unit Price : Manual cent 0.00 Total Price : Fixed cent 0.00

Table 6-2 underlined value is factory setting

6.3 G Value setting

D4	G Value available for standard calibration or not (9.810000 standard setting)
<u>0</u>	G value not available for standard calibration
1	G value available for standard calibration

Table 6-3 underlined value is factory setting

6.4 PLU setting

D5	<div style="display: inline-block; border: 1px solid black; padding: 2px; margin-left: 10px;"> P 1-10 P > 10 </div> PLU key setup
0	P1-10/P>10 deactivate
<u>1</u>	P>10 starts from P11
2	P>10 starts from P21
3	P>10 starts from P31

Table 6-4 underlined value is factory setting

6.5 Error messages

Err H Initial zero too high(over FULLSCALE + 10%)

Err L Initial zero too low (under FULLSCALE – 10%)

Err N Unstable internal value

hhhhhh Overload, when the weight is heavier than the full capacity +9d of the scale

----- Total price over 999999

6.6 Low battery warnings

The display battery symbol lights up when battery voltage is lower than 5.6 V

The display battery symbol starts to flash when battery voltage is lower than 5.5V

The scale will shut off automatically when battery voltage is lower than 5.4V

6.7 LOADCELL connection (for indicator)

PIN1 : E + PIN2 : E- PIN3 : S+ PIN4 : S - PIN5 : FG

7 Cirut diagramm

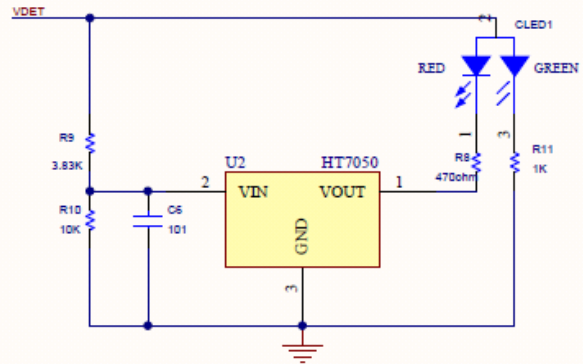
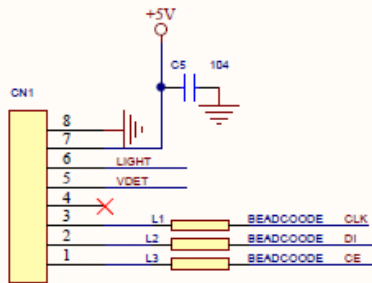
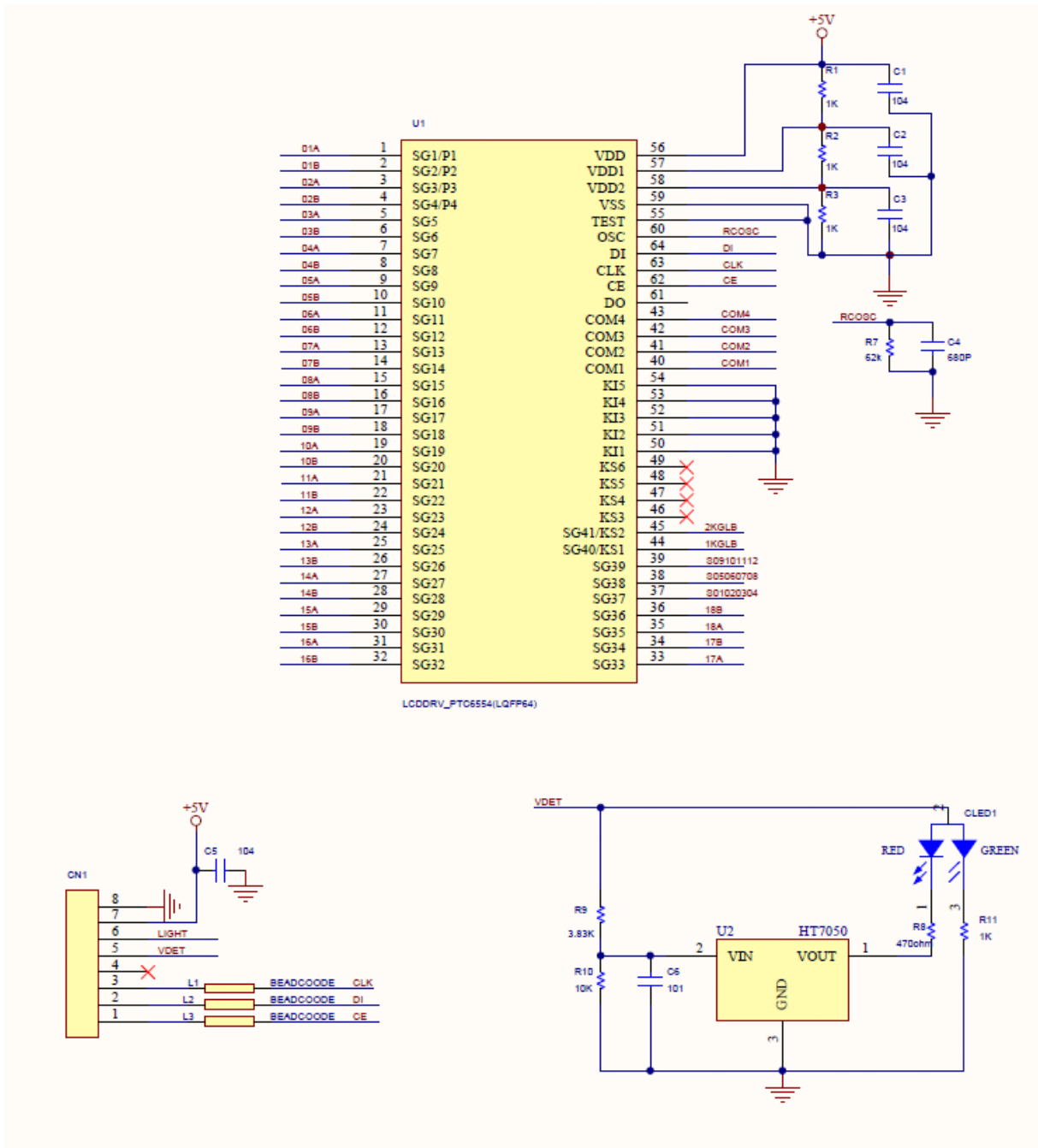

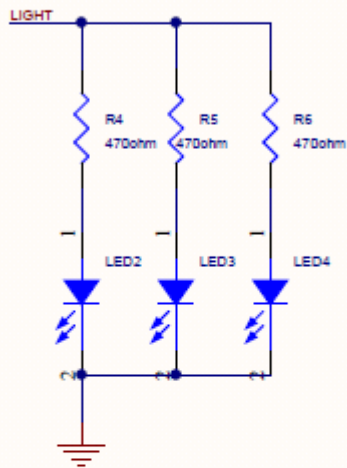

LCD1	
COM1	4
COM2	3
COM3	2
COM4	1
801020304	5
D1A	6
D1B	7
D2A	8
D2B	9
D3A	10
D3B	11
D4A	12
D4B	13
D5A	14
D5B	15
D6A	16
D6B	17
1KGLB	18

LCD3	
COM1	4
COM2	3
COM3	2
COM4	1
809101112	5
13A	6
13B	7
14A	8
14B	9
15A	10
15B	11
16A	12
16B	13
17A	14
17B	15
18A	16
18B	17
18B	18

LCD2	
COM1	4
COM2	3
COM3	2
COM4	1
805060708	5
D7A	6
D7B	7
D8A	8
D8B	9
D9A	10
D9B	11
10A	12
10B	13
11A	14
11B	15
12A	16
12B	17
2KGLB	18

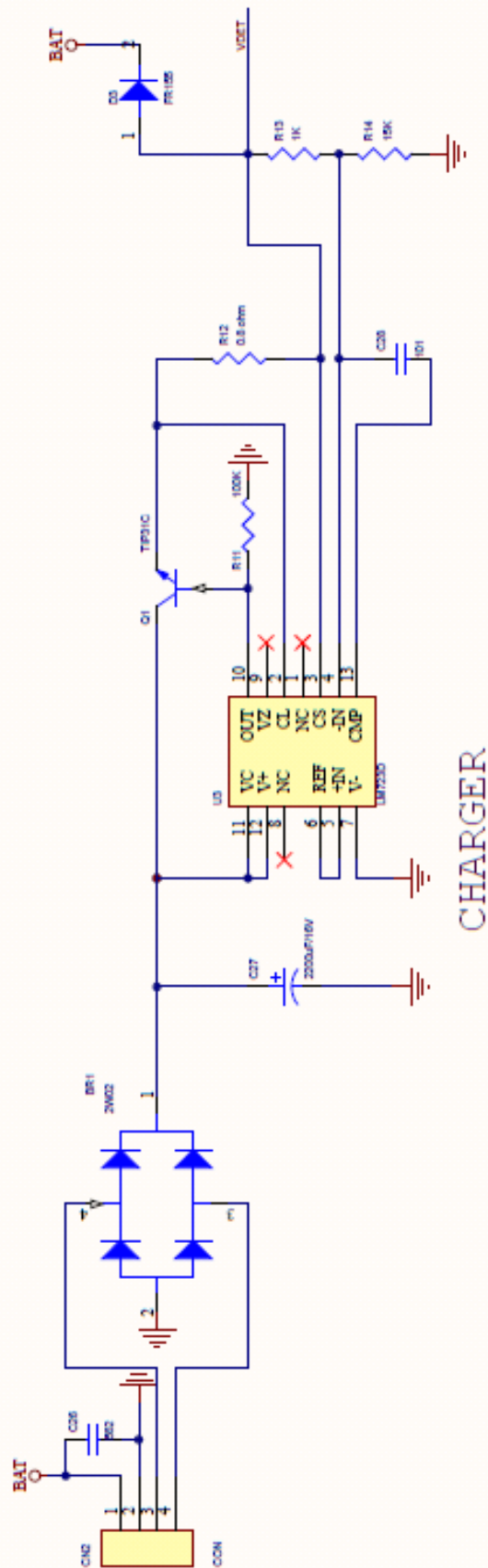
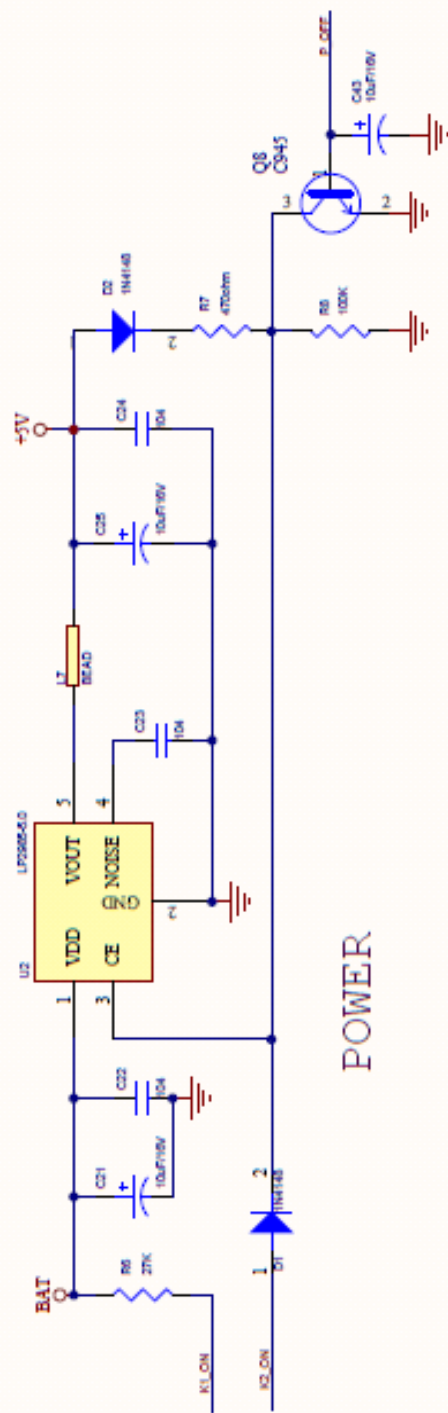

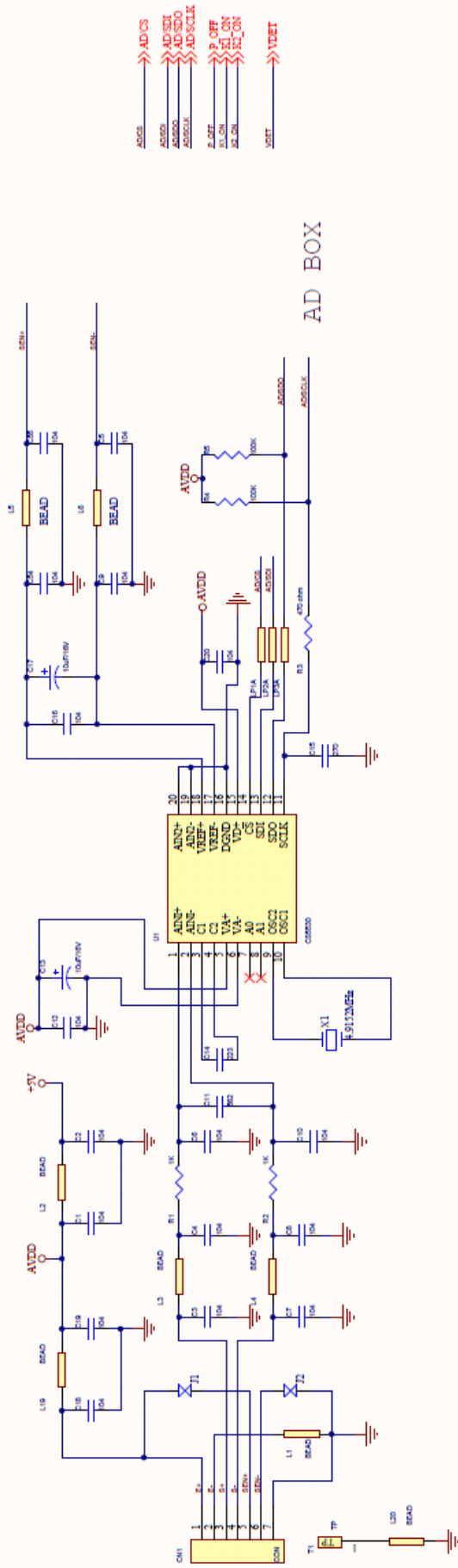

AD BOX

8 Explosion drawing

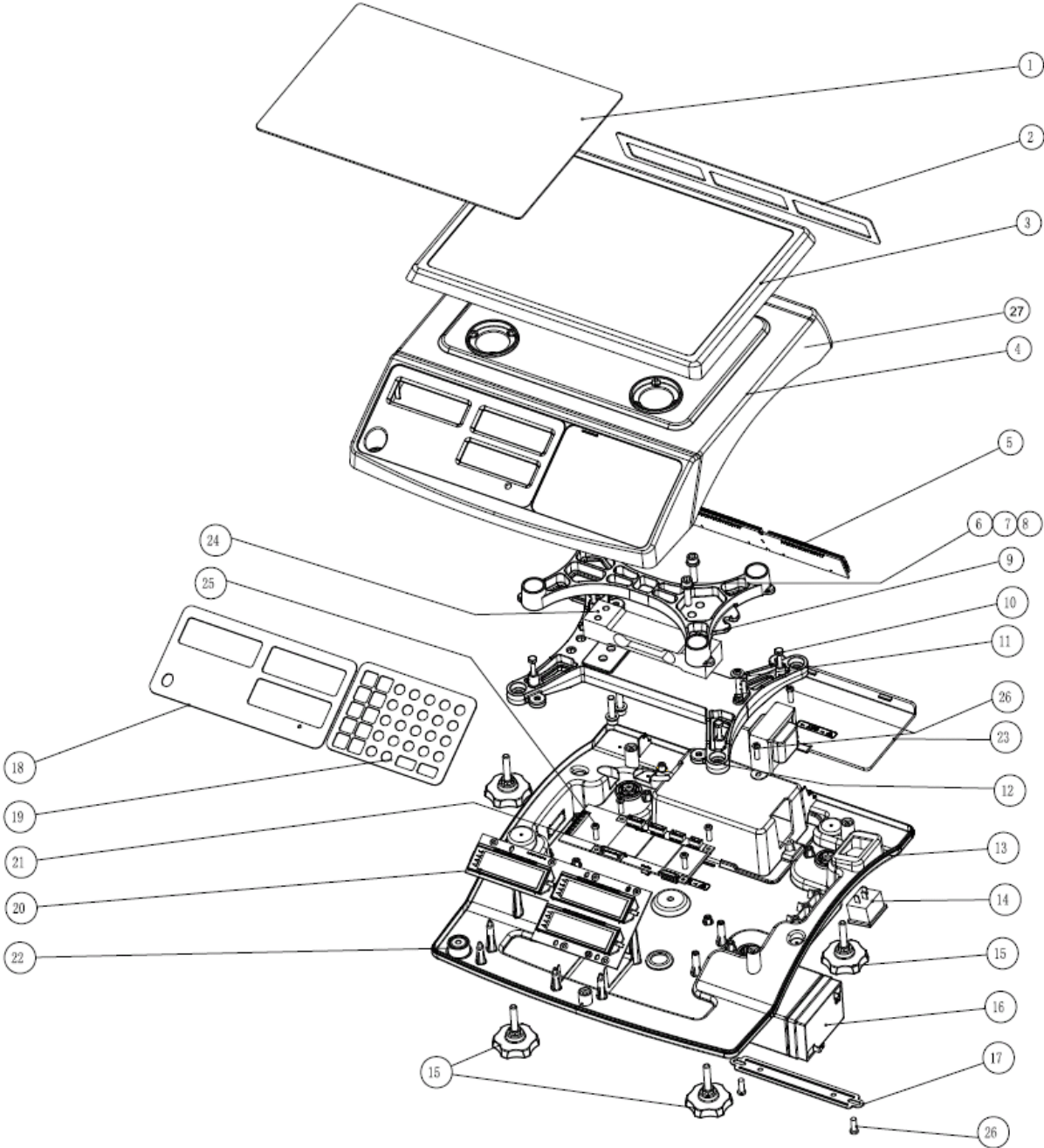

No in drawing	Part number	Product name
24	RRIB-1001	Load cell RIB 6K
24	RRIB-1002	Load cell RIB 10K
24	RRIB-1003	Load cell RIB 30K
20	RRIB-2001	PCB front
21	RRIB-2002	PCB main
	RRIB-2003	PCB, additional display (only HM model)
5	RRIB-2004	PCB, display back
	RRIB-3001	LCD display, for soldering (6 pcs)
19	RRIB-4002	Keypad
14	RRIB-5001	Power socket
	RRIB-5002	Cabel additional display
	RRIB-5003	Cabel display PCB main
1	RRIB-6001	Weighing pan
3	RRIB-6002	Holder Weighing pan
15	RRIB-8001	Adjustable foot
23	RRIB-8002	Battery cover
22	RRIB-8003	Bubble
	RRIB-9001	Dust ring